

6

5

4

3

2

1

REVISION RECORD			
LTR	ECO NO:	APPROVED:	DATE:

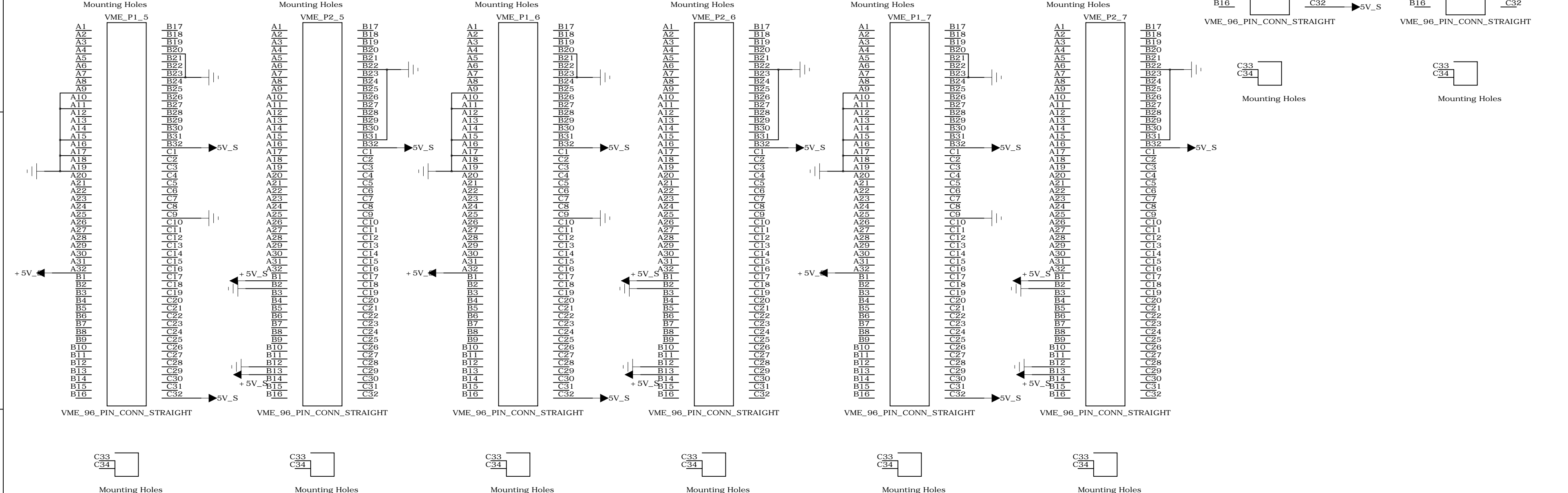
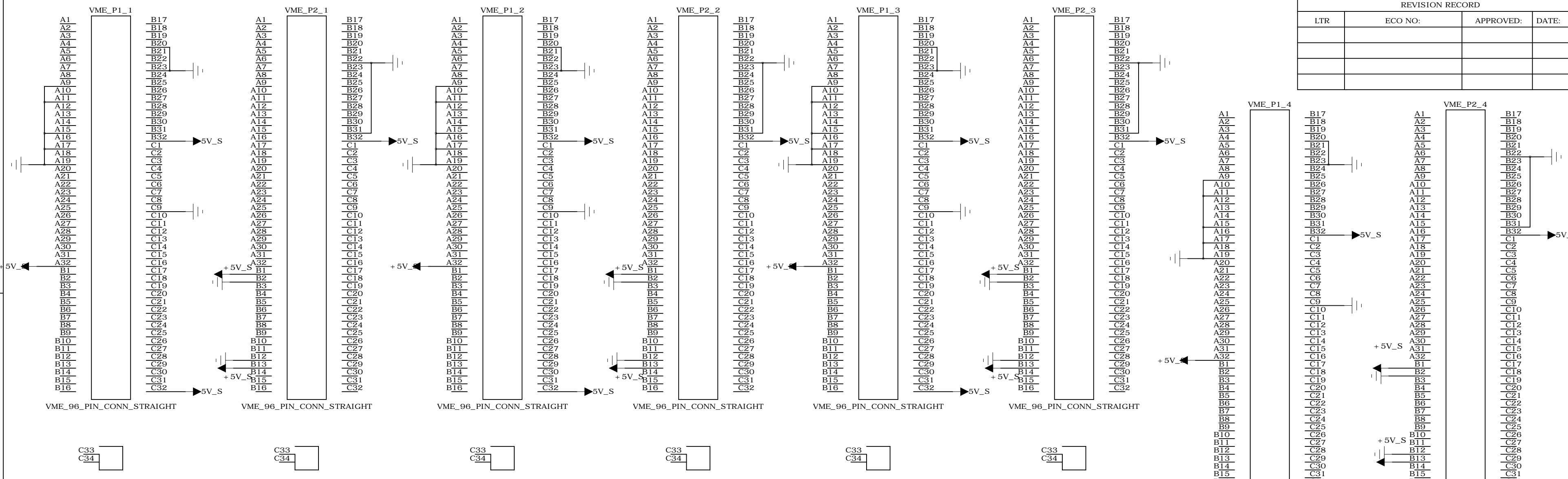

COMPANY: < Company Name >				
TITLE: < Title >				
DRAWN: < Drawn By >	DATED: < Drawn Date >	CODE:	SIZE:	DRAWING NO:
CHECKED: < Checked By >	DATED: < Checked Date >	< Code >	< Drawing Number >	REV:
QUALITY CONTROL: < QC By >	DATED: < QC Date >	Revision		
RELEASED: < Released By >	DATED: < Release Date >	SHEET: 1 OF 6		

D

C

B

A

D

C

B

A

6

5

4

3

2

1

REVISION RECORD			
LTR	ECO NO:	APPROVED:	DATE:

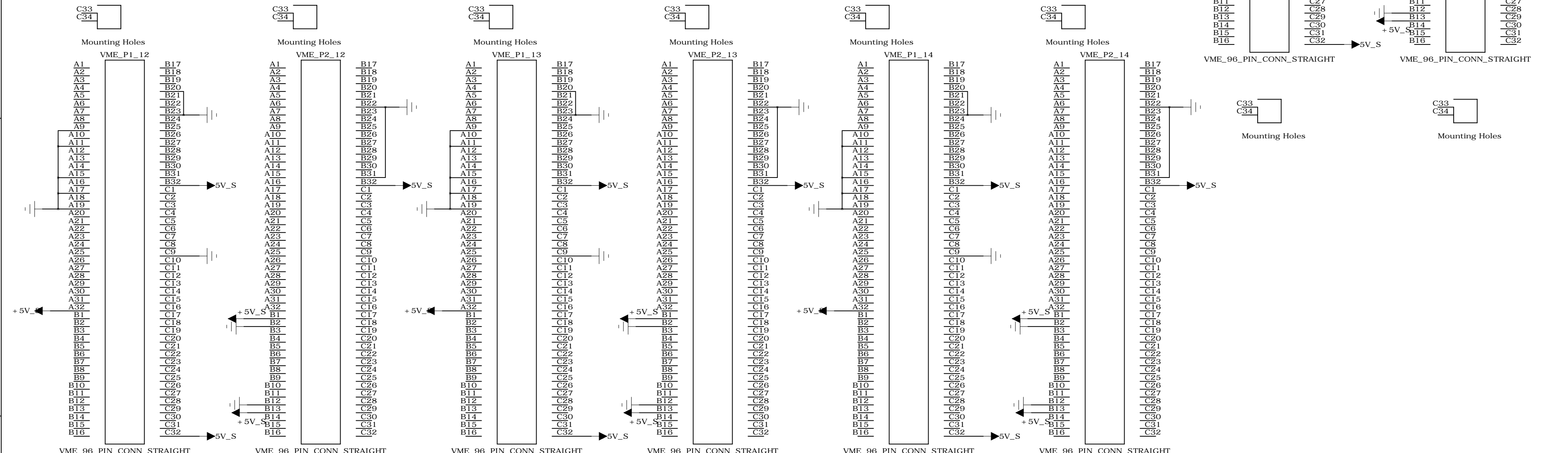
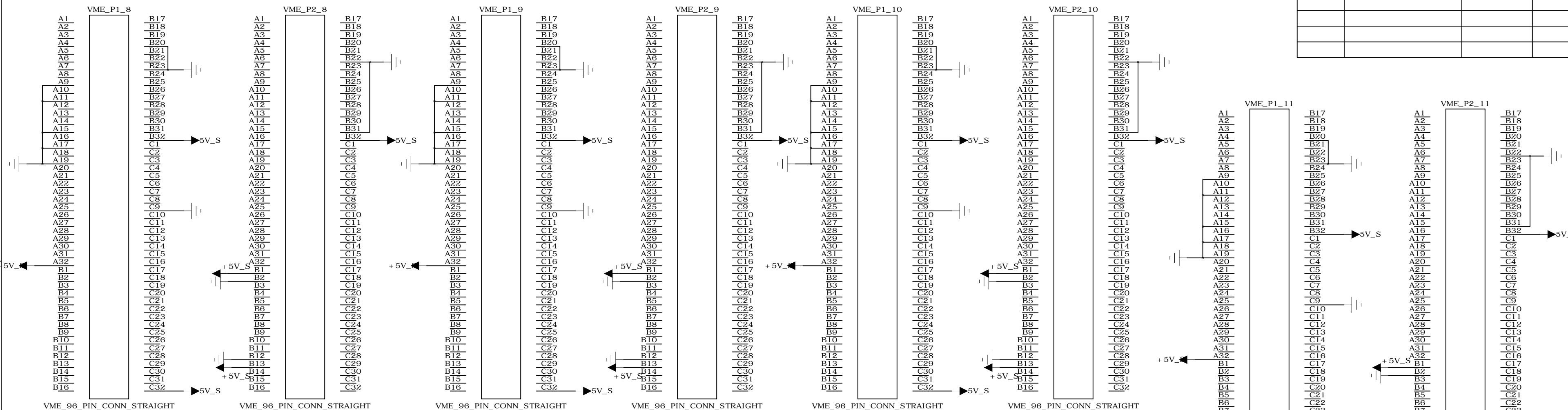

COMPANY: < Company Name >			
TITLE: < Title >			
DRAWN: < Drawn By >	DATED: < Drawn Date >	CODE: < Code >	
CHECKED: < Checked By >	DATED: < Checked Date >	SIZE:	DRAWING NO:
QUALITY CONTROL: < QC By >	DATED: < QC Date >	DRAWING NO: < Drawing Number >	
RELEASED: < Released By >	DATED: < Release Date >	SCALE: < Scale >	REV: < Revision >
SHEET: 2 OF 6			

6

5

4

3

2

1

REVISION RECORD			
LTR	ECO NO:	APPROVED:	DATE:

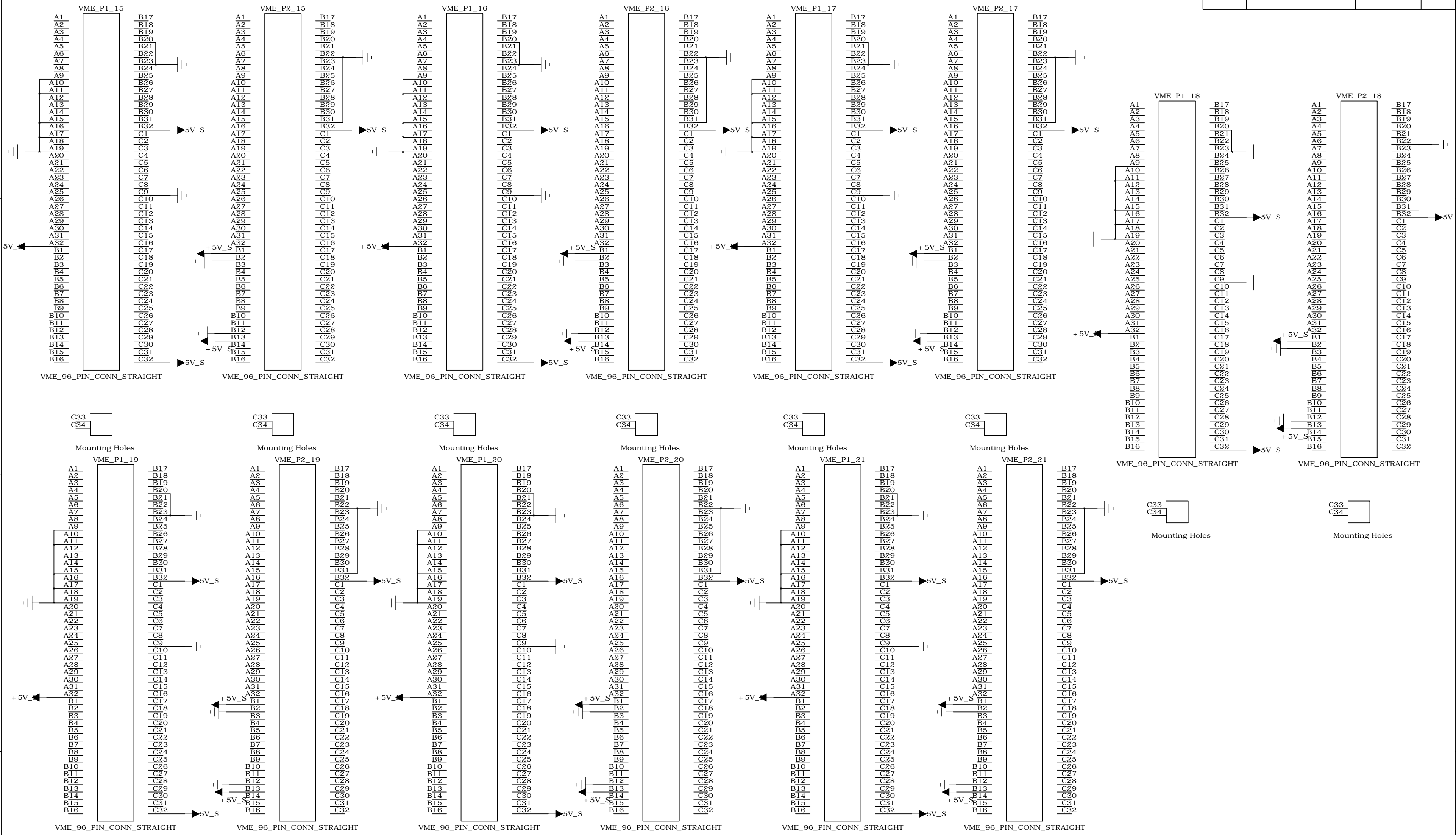

COMPANY: < Company Name >				
TITLE: < Title >				
DRAWN: < Drawn By >	DATED: < Drawn Date >	CODE:	SIZE:	DRAWING NO:
CHECKED: < Checked By >	DATED: < Checked Date >	REV:		
QUALITY CONTROL: < QC By >	DATED: < QC Date >	DRAWING NO: < Code > < Drawing Number > < Revision >		
RELEASED: < Released By >	DATED: < Release Date >	SHEET: 3 OF 6		

DRAWN: < Drawn By >	DATED: < Drawn Date >
CHECKED: < Checked By >	DATED: < Checked Date >
QUALITY CONTROL: < QC By >	DATED: < QC Date >
RELEASED: < Released By >	DATED: < Release Date >

D

C

B

A

D

C

B

A

6 5 4 3 2 1

REVISION RECORD			
LTR	ECO NO:	APPROVED:	DATE:

D

D

C

C

B

B

A

A

COMPANY: < Company Name >			
TITLE: < Title >			
DRAWN: < Drawn By >	DATED: < Drawn Date >	CODE: < Code >	
CHECKED: < Checked By >	DATED: < Checked Date >	SIZE: < Drawing Number >	REV: < Revision >
QUALITY CONTROL: < QC By >	DATED: < QC Date >	SHEET: 4 OF 6	
RELEASED: < Released By >	DATED: < Release Date >	SCALE: < Scale >	

DRAWN: < Drawn By >	DATED: < Drawn Date >
CHECKED: < Checked By >	DATED: < Checked Date >
QUALITY CONTROL: < QC By >	DATED: < QC Date >
RELEASED: < Released By >	DATED: < Release Date >

6

5

4

3

2

1

REVISION RECORD			
LTR	ECO NO:	APPROVED:	DATE:

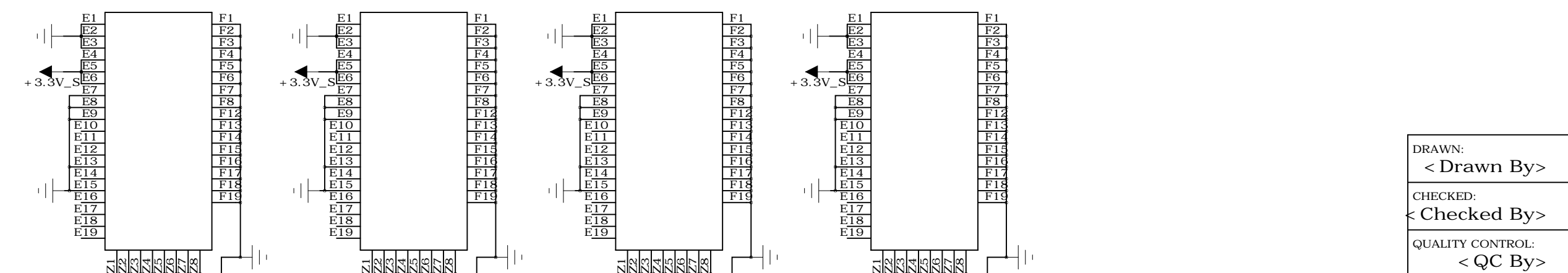
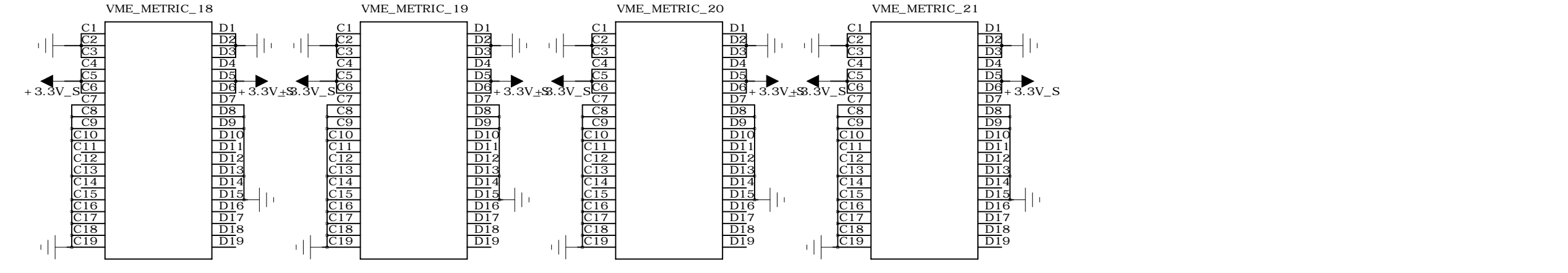
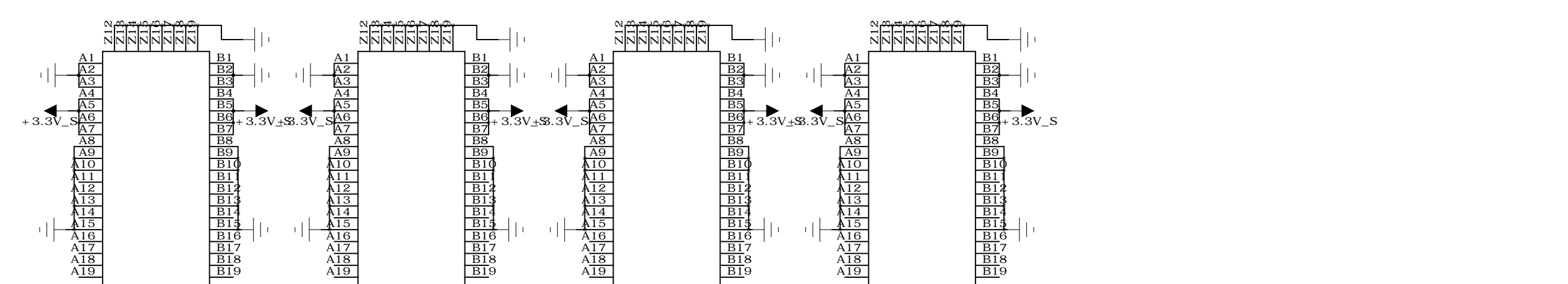
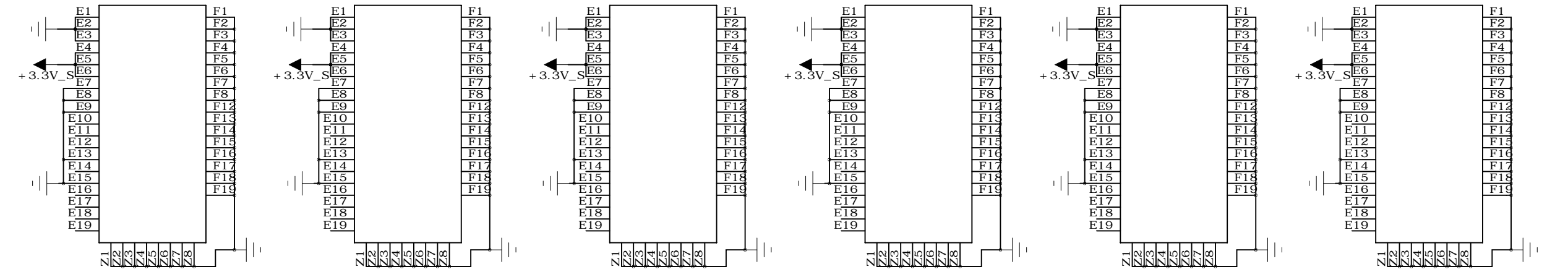
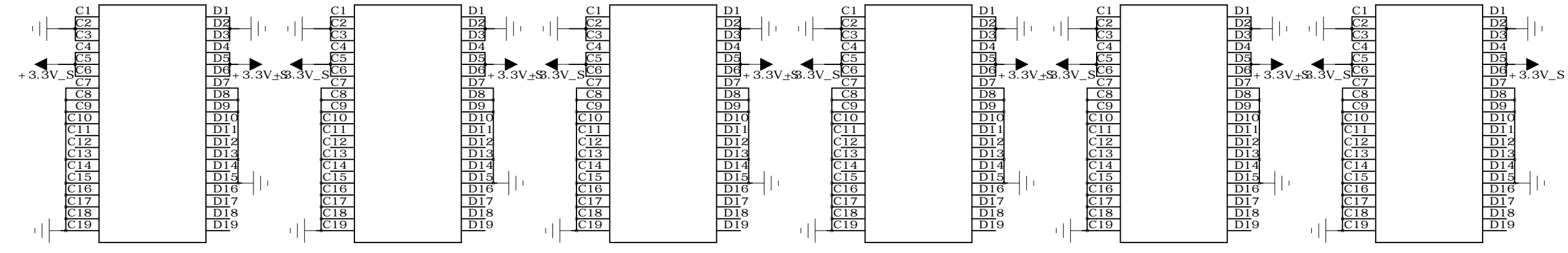
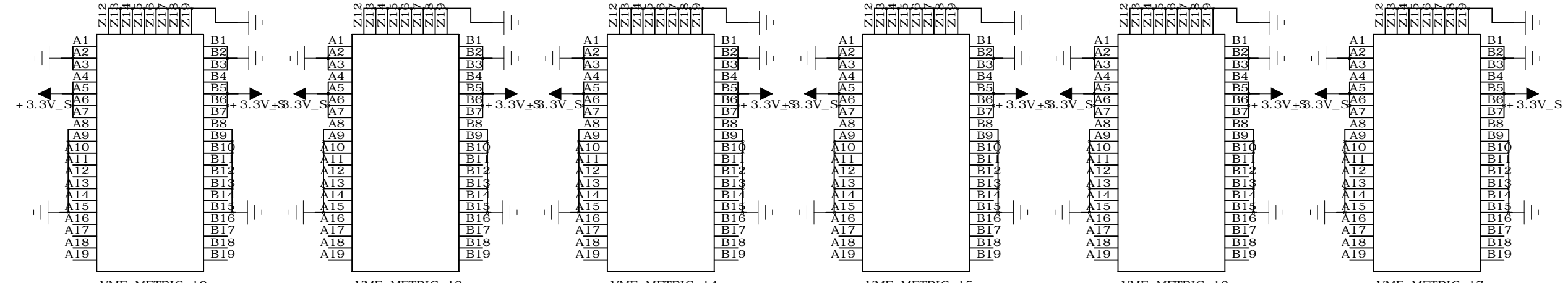

COMPANY: < Company Name >			
TITLE: < Title >			
DRAWN: < Drawn By >	DATED: < Drawn Date >	CODE:	SIZE:
CHECKED: < Checked By >	DATED: < Checked Date >	DRAWING NO:	
QUALITY CONTROL: < QC By >	DATED: < QC Date >	REV:	
RELEASED: < Released By >	DATED: < Release Date >	SHEET: 5 OF 6	

< Code > < Drawing Number > < Revision >

6

5

4

3

2

1

Power Supply to board 6-pin screw terminals

REVISION RECORD			
LTR	ECO NO:	APPROVED:	DATE:

Ground Taps

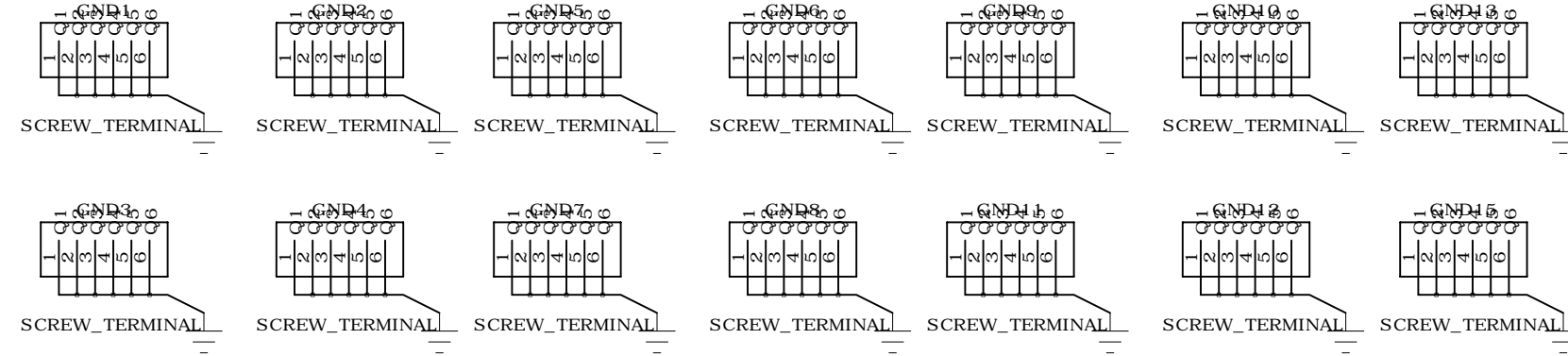

3.3 V Power Taps

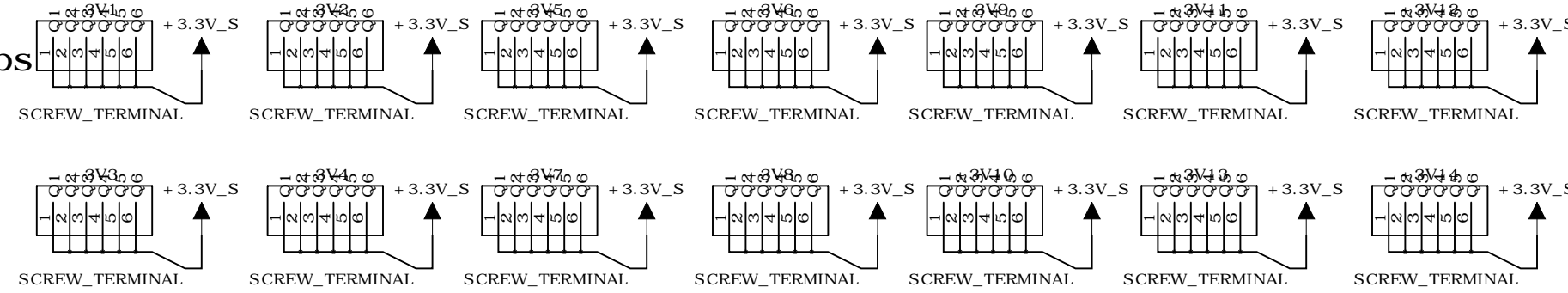

5 V Power Taps

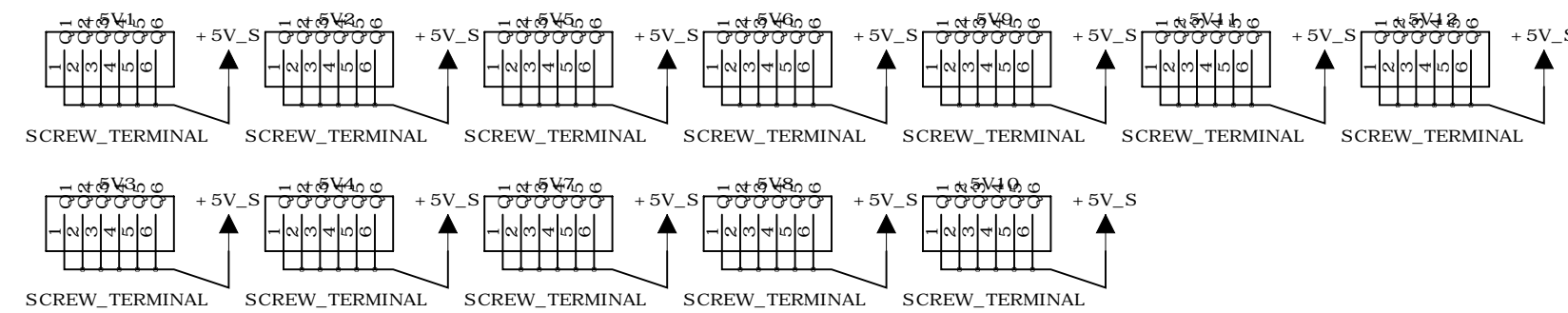

COMPANY: < Company Name >			
TITLE: < Title >			
DRAWN: < Drawn By >	DATED: < Drawn Date >	CODE:	SIZE:
CHECKED: < Checked By >	DATED: < Checked Date >	DRAWING NO:	
QUALITY CONTROL: < QC By >	DATED: < QC Date >	REV:	
RELEASED: < Released By >	DATED: < Release Date >	SHEET: 6 OF 6	

DRAWN: < Drawn By >		DATED: < Drawn Date >	
CHECKED: < Checked By >		DATED: < Checked Date >	
QUALITY CONTROL: < QC By >		DATED: < QC Date >	
RELEASED: < Released By >		DATED: < Release Date >	
CODE: < Code >		SIZE: < Drawing Number >	
SCALE: < Scale >		REV: < Revision >	