



UNIVERSITY  
of HAWAII®  
MĀNOA

**High Energy Physics Group**  
**Instrumentation Development Laboratory**  
2505 Correa Road, Honolulu, HI 96822

**Production Documentation for:**

**Project Name:** VMEBackplane  
**Board Name:** VMEbackplane  
**IDL num:** IDL\_17\_12  
**Revision:** A  
**Variant:** [No Variations]

**Designer:** Jose Duron  
**Drawn by:** Jose Duron  
**Approved by:**

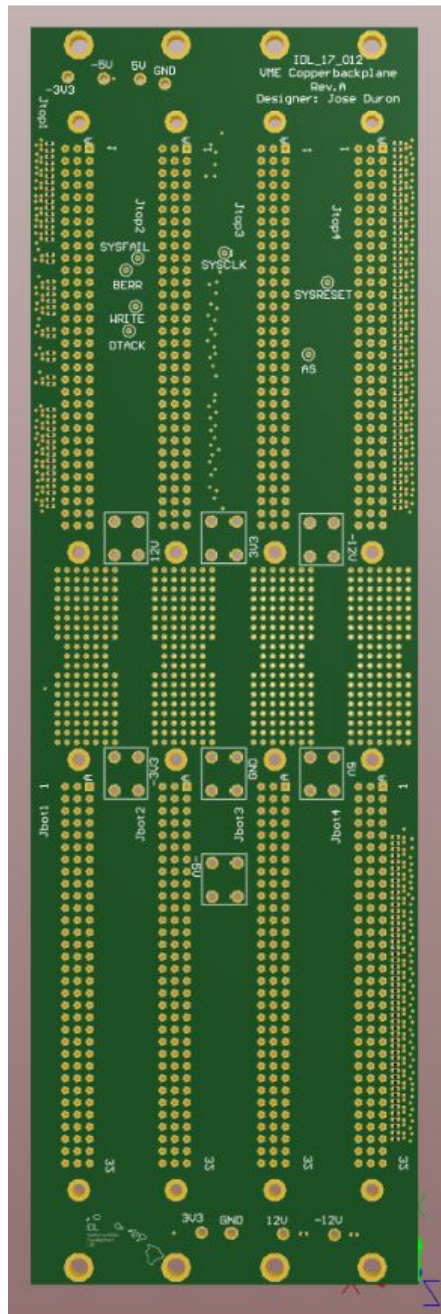

High Energy Physics Group, Instrumentation Development Lab	Designer: Jose Duron	IDLAB design #: IDL_17_12
Project name: <b>VMEBackplane</b>	Drawn By: Jose Duron	Revision: A
Board name: <b>VMEbackplane</b>	Approved By:	Variant: [No Variations]
		Modif. Date: 10/8/2017
		Sheet 1 of 3



UNIVERSITY  
of HAWAII®  
MĀNOA

IDL\_IDL\_17\_12\_VME  
IDL\_17\_12\_VME.SchDoc

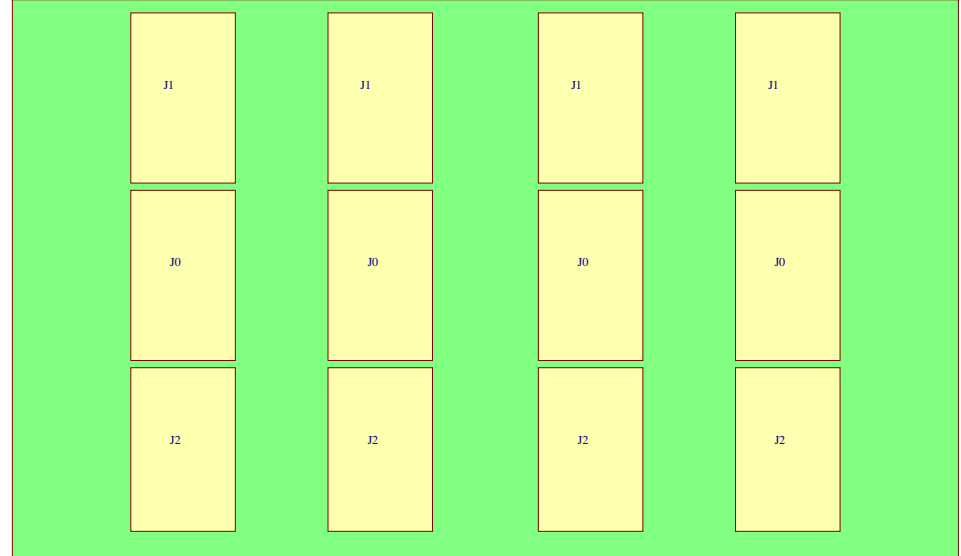

NetLabel8

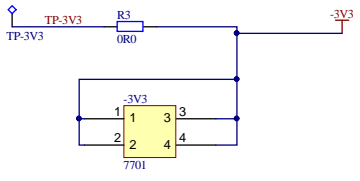
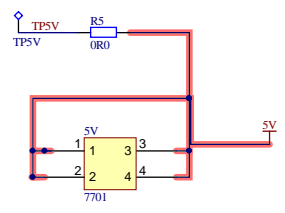
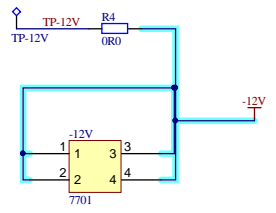
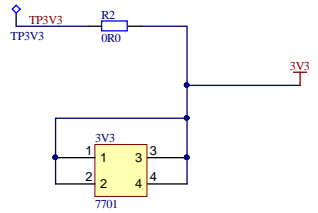
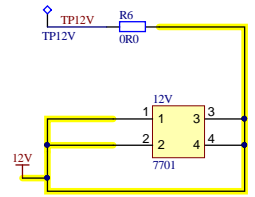
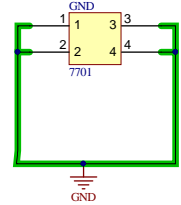
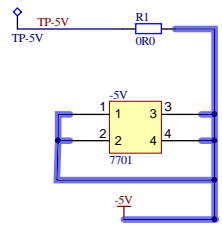

High Energy Physics Group, Instrumentation Development Lab	Designer: Jose Duron	IDLAB design #: IDL_17_12
Board: <b>VMEbackplane</b>	Drawn By: Jose Duron	Revision: A
Sheet Title: <b>Top</b>	Approved By:	Variant: [No Variations]
		Modif. Date: 9/19/2017
		Sheet 2 of 3



IDL\_17\_12\_J0  
IDL\_17\_12\_J0.SchDoc

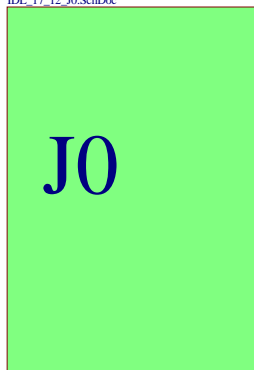

IDL\_17\_12\_J1  
IDL\_17\_12\_J1.SchDoc

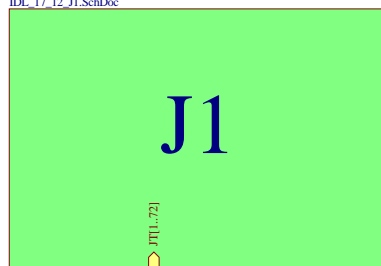

J1[1..72]

JT

Repeat(A)

Repeat(IDL\_17\_12\_TerA.1.72)  
IDL\_17\_12\_TerA.SchDoc

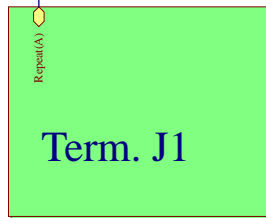

Term. J1

IDL\_17\_12\_J2  
IDL\_17\_12\_J2.SchDoc

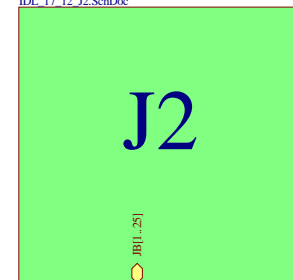

J2[1..25]

JB

Repeat(B)

Repeat(IDL\_17\_12\_TerB.1.25)  
IDL\_17\_12\_TerB.SchDoc

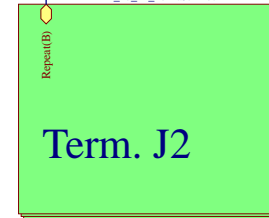

Term. J2

High Energy Physics Group, Instrumentation Development Lab	Designer: Jose Duron	IDLAB design #: IDL_17_12
Board: <b>VMEbackplane</b>	Drawn By: Jose Duron	Revision: A
Sheet Title: <b>VME</b>	Approved By:	Variant: [No Variations]
		Modif. Date: 9/10/2017
		Sheet 3 of *



UNIVERSITY  
of HAWAII  
MĀNOA

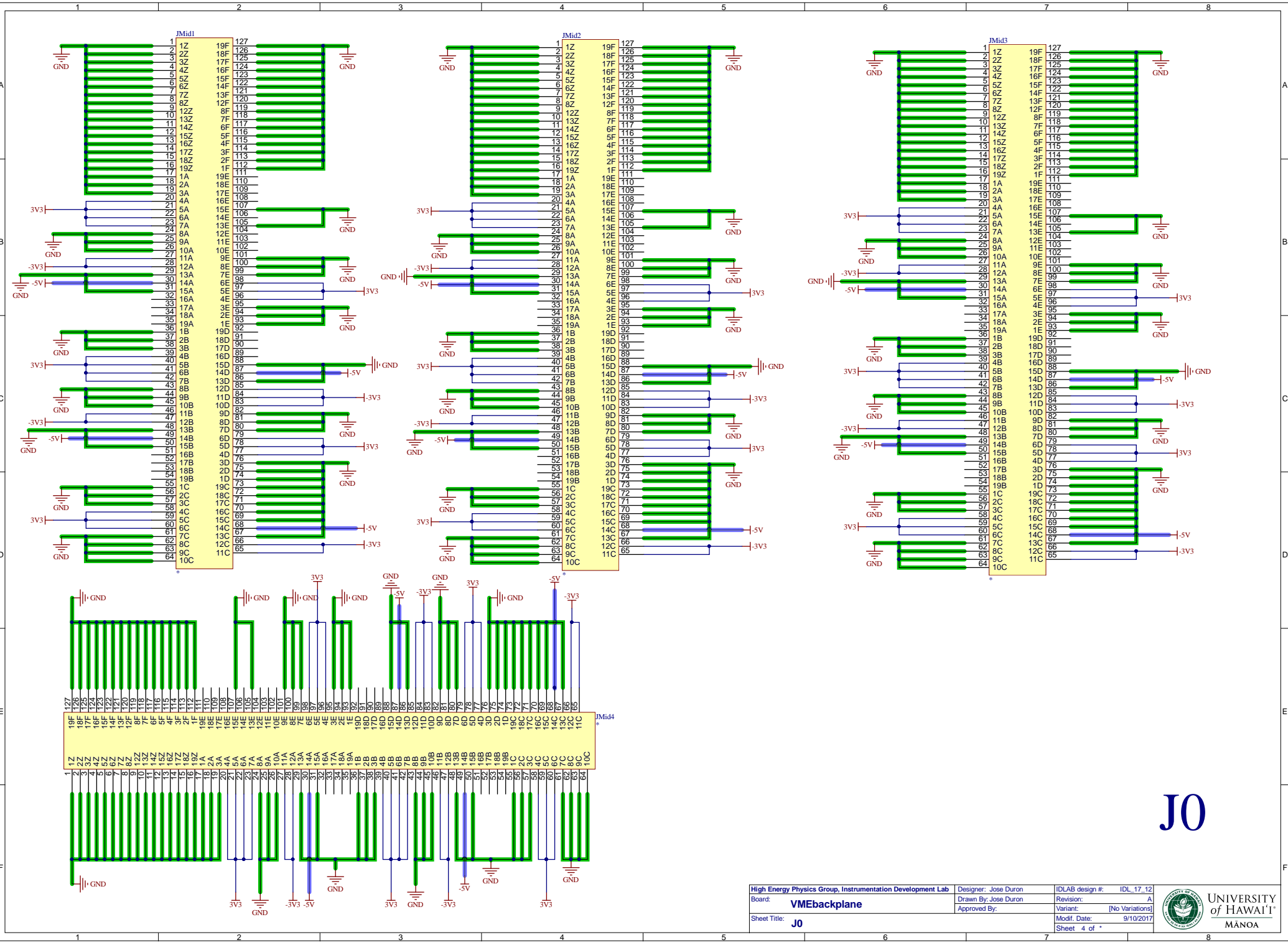

J0





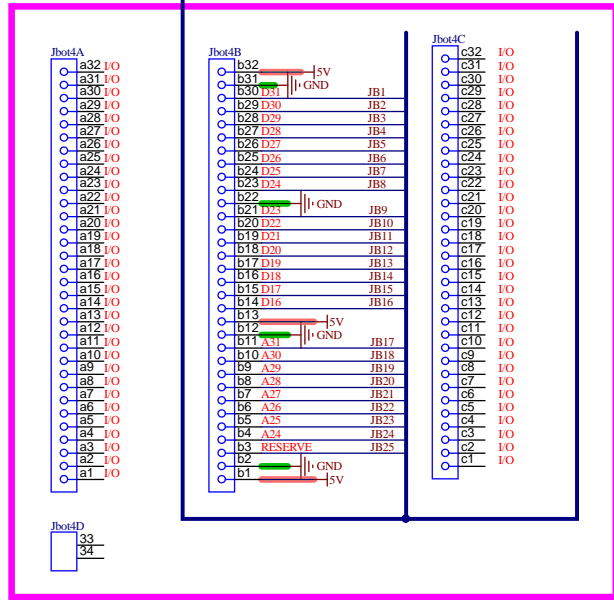
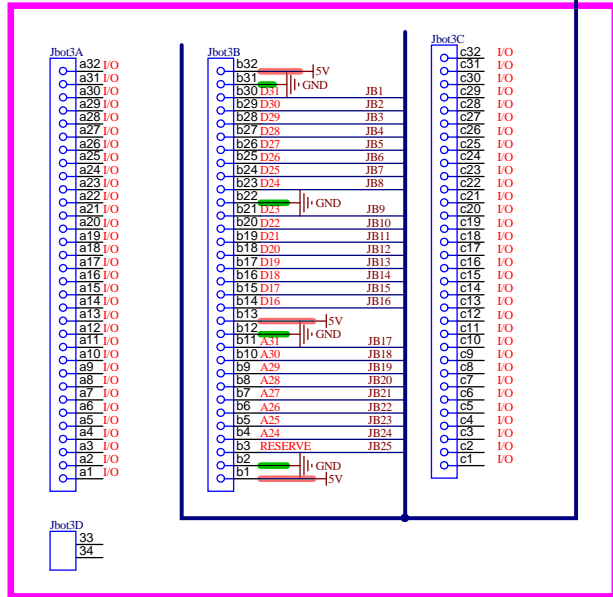
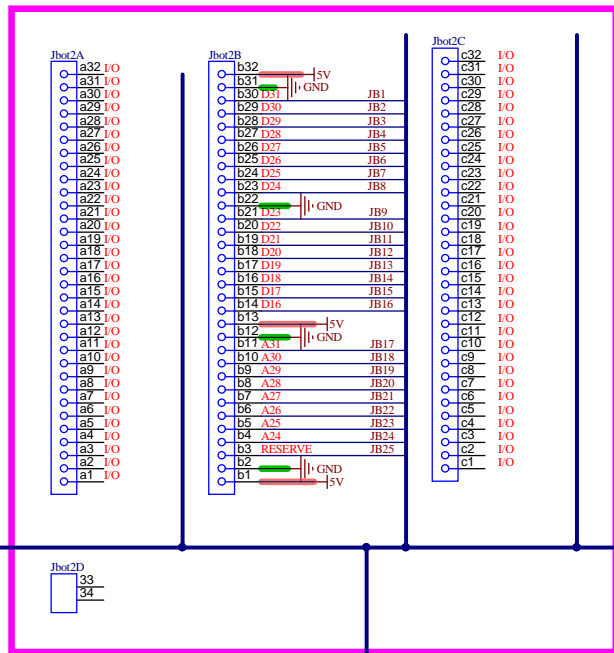
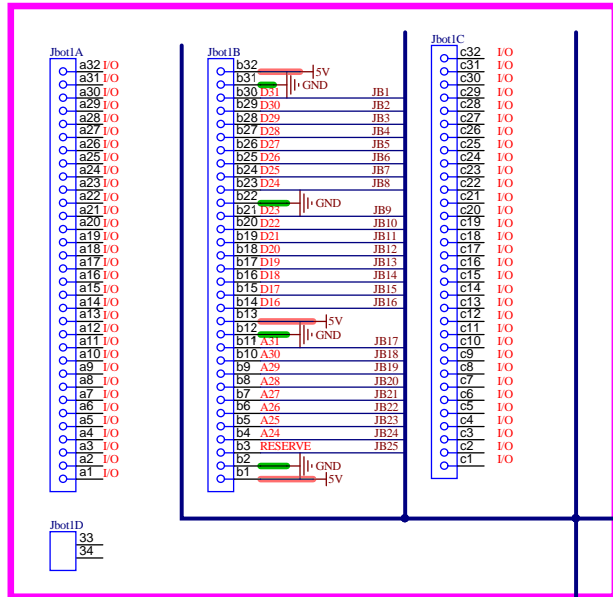

# Termination

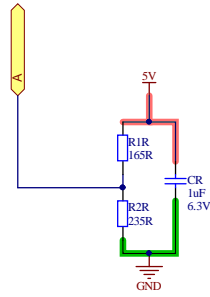

High Energy Physics Group, Instrumentation Development Lab	Designer: Jose Duron	IDLAB design #: IDL_17_12
Board: VMEbackplane	Drawn By: Jose Duron	Revision: A
Sheet Title: Termination A	Approved By:	Variant: [No Variations]
		Modif. Date: 10/9/2017
		Sheet 7 of *



# Termination

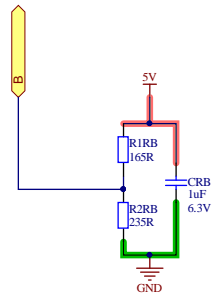

High Energy Physics Group, Instrumentation Development Lab	Designer: Jose Duron	IDLAB design #: IDL_17_12
Board: <b>VMEbackplane</b>	Drawn By: Jose Duron	Revision: A
Sheet Title: <b>Termination B</b>	Approved By:	Variant: [No Variations]
		Modif. Date: 10/9/2017
		Sheet 8 of *





